

General Description

The GreenMOS[®] high voltage MOSFET utilizes charge balance technology to achieve outstanding low on-resistance and lower gate charge. It is engineered to minimize conduction loss, provide superior switching performance and robust avalanche capability.

The GreenMOS[®] Generic series is optimized for extreme switching performance to minimize switching loss. It is tailored for high power density applications to meet the highest efficiency standards.

Features

- Low $R_{DS(ON)}$ & FOM
- Extremely low switching loss
- Excellent stability and uniformity





Applications

- PC power
- LED lighting
- Telecom power
- Server power
- EV Charger
- Solar/UPS

Key Performance Parameters

| Parameter | Value | Unit |
|--------------------------------|-------|----------|
| $V_{DS, min} @ T_{j(max)}$ | 550 | V |
| $I_D, pulse$ | 9 | A |
| $R_{DS(ON), max} @ V_{GS}=10V$ | 1.5 | Ω |
| Q_g | 4.84 | nC |

Marking Information

| Product Name | Package | Marking |
|--------------|---------|------------|
| OSG50R1K5PF | TO220 | OSG50R1K5P |

Package & Pin Information

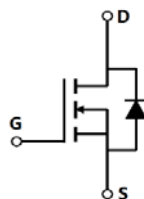

Absolute Maximum Ratings at $T_j=25^\circ\text{C}$ unless otherwise noted

| Parameter | Symbol | Value | Unit |
|---|----------------|------------|------------------|
| Drain-source voltage | V_{DS} | 500 | V |
| Gate-source voltage | V_{GS} | ± 30 | V |
| Continuous drain current ¹⁾ , $T_C=25^\circ\text{C}$ | I_D | 3 | A |
| Continuous drain current ¹⁾ , $T_C=100^\circ\text{C}$ | | 1.9 | |
| Pulsed drain current ²⁾ , $T_C=25^\circ\text{C}$ | $I_{D, pulse}$ | 9 | A |
| Continuous diode forward current ¹⁾ , $T_C=25^\circ\text{C}$ | I_S | 3 | A |
| Diode pulsed current ²⁾ , $T_C=25^\circ\text{C}$ | $I_{S, pulse}$ | 9 | A |
| Power dissipation ³⁾ , $T_C=25^\circ\text{C}$ | P_D | 20 | W |
| Single pulsed avalanche energy ⁵⁾ | E_{AS} | 60 | mJ |
| MOSFET dv/dt ruggedness, $V_{DS}=0\dots 480\text{ V}$ | dv/dt | 50 | V/ns |
| Reverse diode dv/dt, $V_{DS}=0\dots 480\text{ V}$, $I_{SD}\leq I_D$ | dv/dt | 15 | V/ns |
| Operation and storage temperature | T_{stg}, T_j | -55 to 150 | $^\circ\text{C}$ |

Thermal Characteristics

| Parameter | Symbol | Value | Unit |
|--|-----------------|-------|--------------------|
| Thermal resistance, junction-case | $R_{\theta JC}$ | 6.25 | $^\circ\text{C/W}$ |
| Thermal resistance, junction-ambient ⁴⁾ | $R_{\theta JA}$ | 62 | $^\circ\text{C/W}$ |

Electrical Characteristics at $T_j=25^\circ\text{C}$ unless otherwise specified

| Parameter | Symbol | Min. | Typ. | Max. | Unit | Test condition |
|----------------------------------|--------------|------|------|------|---------------|--|
| Drain-source breakdown voltage | BV_{DSS} | 500 | | | V | $V_{GS}=0\text{ V}$, $I_D=250\ \mu\text{A}$ |
| | | 550 | 630 | | | $V_{GS}=0\text{ V}$, $I_D=250\ \mu\text{A}$, $T_j=150^\circ\text{C}$ |
| Gate threshold voltage | $V_{GS(th)}$ | 2.9 | | 3.9 | V | $V_{DS}=V_{GS}$, $I_D=250\ \mu\text{A}$ |
| Drain-source on-state resistance | $R_{DS(on)}$ | | 1.3 | 1.5 | Ω | $V_{GS}=10\text{ V}$, $I_D=1.5\text{ A}$ |
| | | | 3 | | | $V_{GS}=10\text{ V}$, $I_D=1.5\text{ A}$, $T_j=150^\circ\text{C}$ |
| Gate-source leakage current | I_{GSS} | | | 100 | nA | $V_{GS}=30\text{ V}$ |
| | | | | -100 | | $V_{GS}=-30\text{ V}$ |
| Drain-source leakage current | I_{DSS} | | | 1 | μA | $V_{DS}=500\text{ V}$, $V_{GS}=0\text{ V}$ |

Dynamic Characteristics

| Parameter | Symbol | Min. | Typ. | Max. | Unit | Test condition |
|------------------------------|--------------|------|-------|------|------|--|
| Input capacitance | C_{iss} | | 130.6 | | pF | $V_{GS}=0\text{ V}$, $V_{DS}=50\text{ V}$, $f=1\text{ MHz}$ |
| Output capacitance | C_{oss} | | 51.7 | | pF | |
| Reverse transfer capacitance | C_{rss} | | 1 | | pF | |
| Turn-on delay time | $t_{d(on)}$ | | 15.3 | | ns | $V_{GS}=10\text{ V}$, $V_{DS}=400\text{ V}$, $R_G=2\ \Omega$, $I_D=2\text{ A}$ |
| Rise time | t_r | | 4.8 | | ns | |
| Turn-off delay time | $t_{d(off)}$ | | 22 | | ns | |
| Fall time | t_f | | 7.6 | | ns | |

Gate Charge Characteristics

| Parameter | Symbol | Min. | Typ. | Max. | Unit | Test condition |
|----------------------|---------------|------|------|------|------|---|
| Total gate charge | Q_g | | 4.84 | | nC | $V_{GS}=10\text{ V}$, $V_{DS}=400\text{ V}$, $I_D=2\text{ A}$ |
| Gate-source charge | Q_{gs} | | 0.87 | | nC | |
| Gate-drain charge | Q_{gd} | | 1.93 | | nC | |
| Gate plateau voltage | $V_{plateau}$ | | 5.8 | | V | |

Body Diode Characteristics

| Parameter | Symbol | Min. | Typ. | Max. | Unit | Test condition |
|-------------------------------|-----------|------|-------|------|---------------|--|
| Diode forward voltage | V_{SD} | | | 1.3 | V | $I_S=3\text{ A}$, $V_{GS}=0\text{ V}$ |
| Reverse recovery time | t_{rr} | | 146.1 | | ns | $V_R=400\text{ V}$, $I_S=2\text{ A}$, $di/dt=100\text{ A}/\mu\text{s}$ |
| Reverse recovery charge | Q_{rr} | | 0.7 | | μC | |
| Peak reverse recovery current | I_{rrm} | | 10.1 | | A | |

Note

- 1) Calculated continuous current based on maximum allowable junction temperature.
- 2) Repetitive rating; pulse width limited by max. junction temperature.
- 3) P_d is based on max. junction temperature, using junction-case thermal resistance.
- 4) The value of $R_{\theta JA}$ is measured with the device mounted on 1 in 2 FR-4 board with 2oz. Copper, in a still air environment with $T_a=25\text{ }^\circ\text{C}$.
- 5) $V_{DD}=50\text{ V}$, $V_{GS}=10\text{ V}$, $L=60\text{ mH}$, starting $T_j=25\text{ }^\circ\text{C}$.

Electrical Characteristics Diagrams

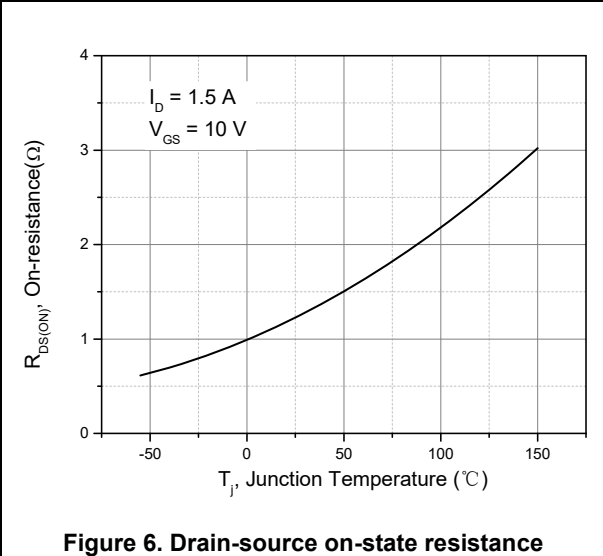
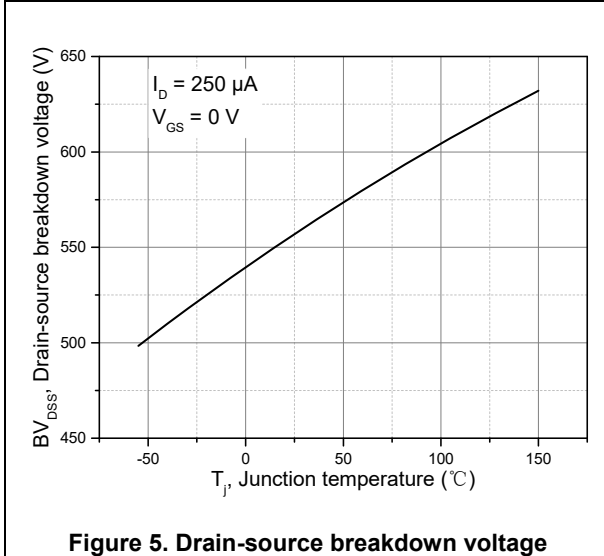
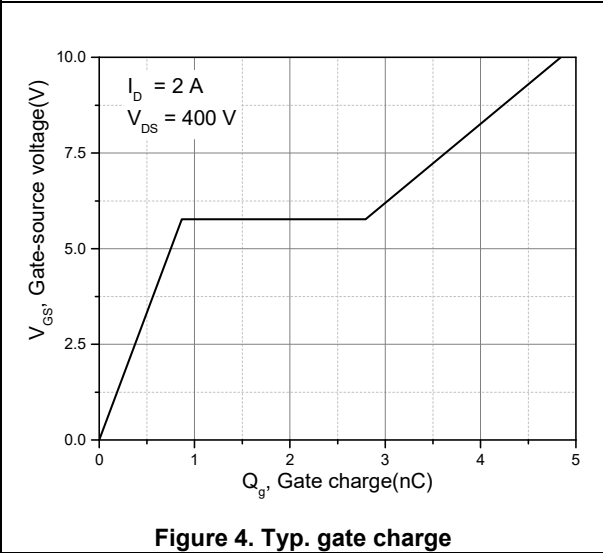
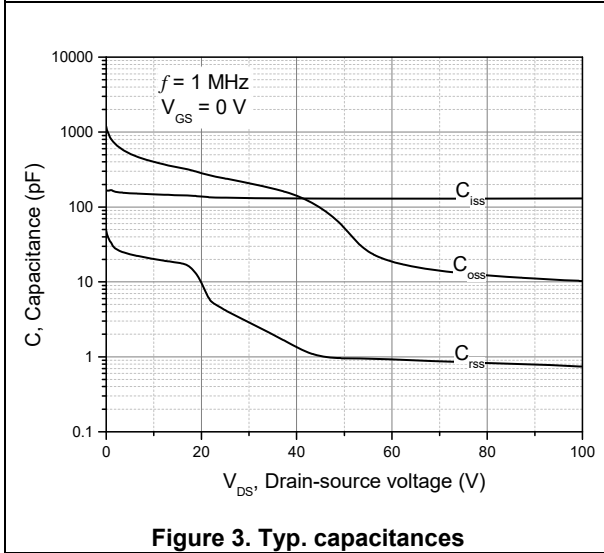
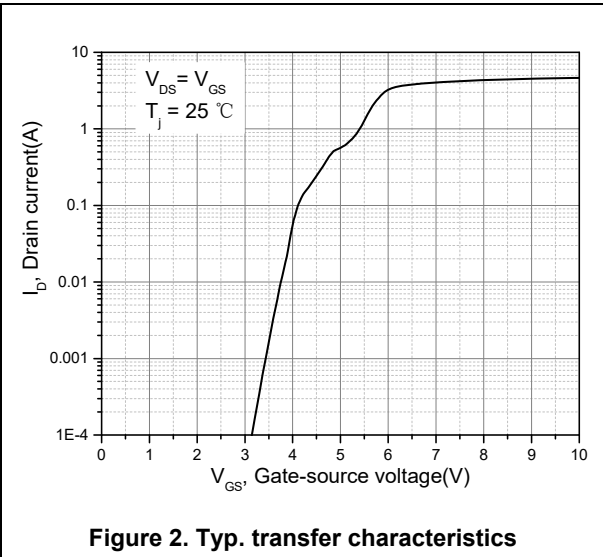
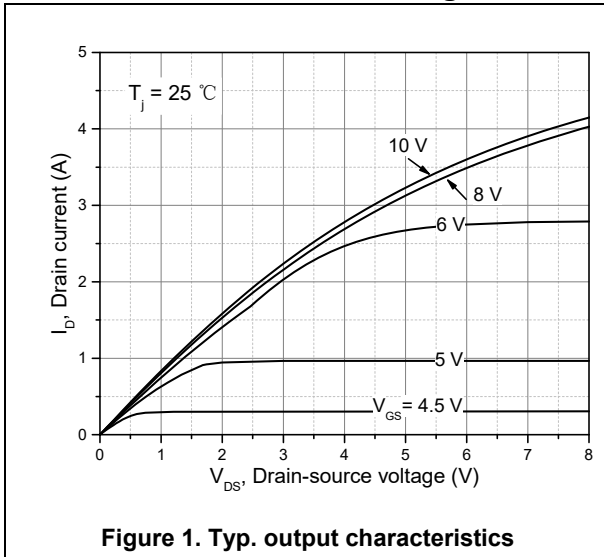

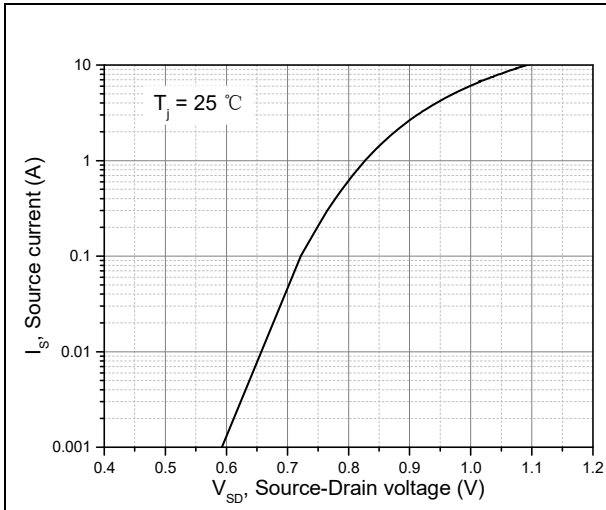

Figure 7. Forward characteristic of body diode

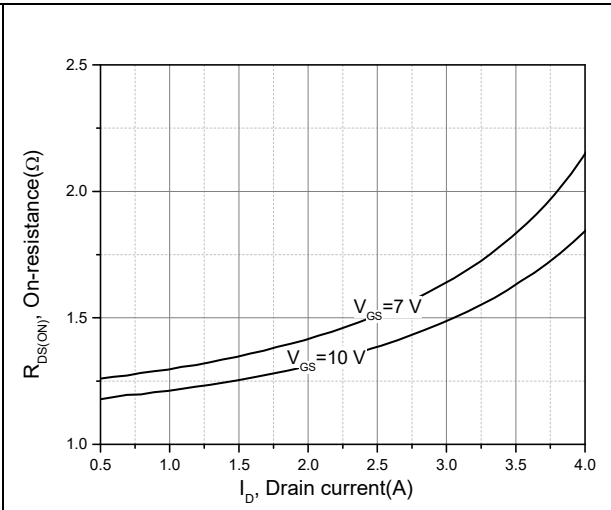

Figure 8. Drain-source on-state resistance

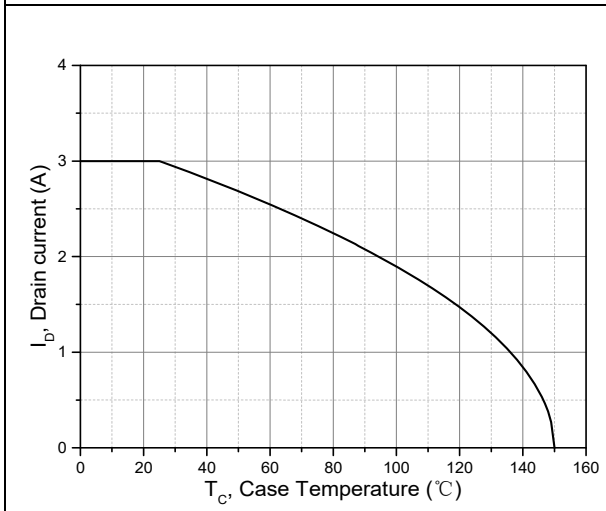

Figure 9. Drain current

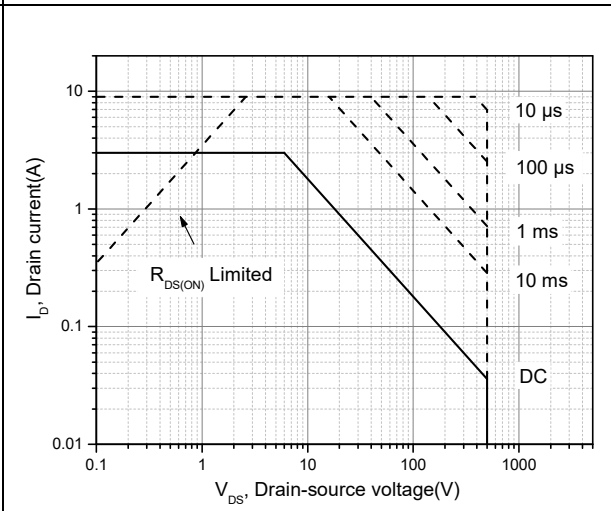

Figure 10. Safe operation area T_C=25 °C

Test circuits and waveforms

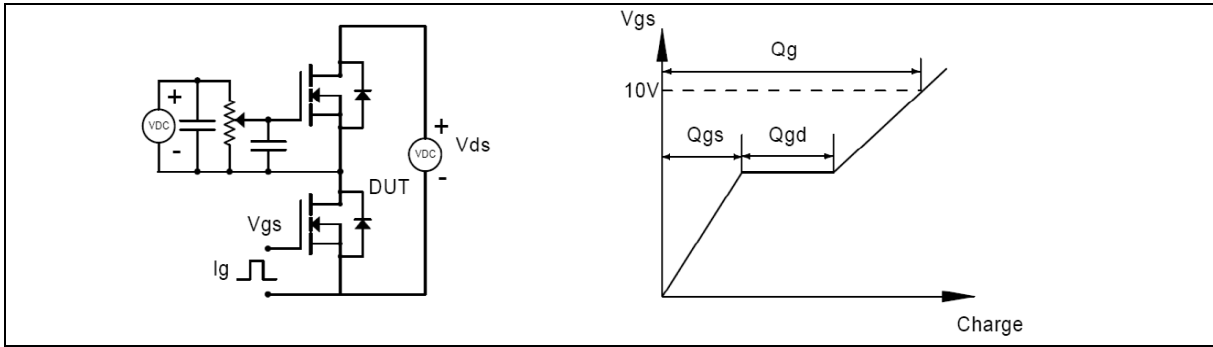

Figure 1. Gate charge test circuit & waveform



Figure 2. Switching time test circuit & waveforms

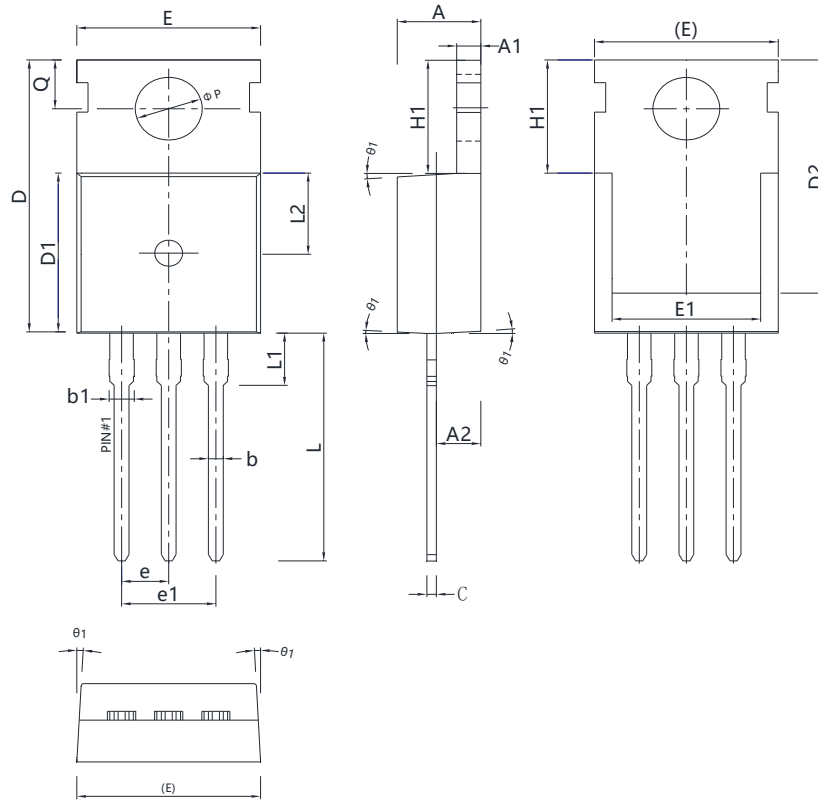

Figure 3. Unclamped inductive switching (UIS) test circuit & waveforms



Figure 4. Diode reverse recovery test circuit & waveforms

Package Information



| Symbol | mm | | |
|-----------|----------|-------|-------|
| | Min | Nom | Max |
| A | 4.40 | 4.50 | 4.60 |
| A1 | 1.27 | 1.30 | 1.33 |
| A2 | 2.30 | 2.40 | 2.50 |
| b | 0.70 | - | 0.90 |
| b1 | 1.27 | - | 1.40 |
| c | 0.45 | 0.50 | 0.60 |
| D | 15.30 | 15.70 | 16.10 |
| D1 | 9.10 | 9.20 | 9.30 |
| D2 | 13.10 | - | 13.70 |
| E | 9.70 | 9.90 | 10.20 |
| E1 | 7.80 | 8.00 | 8.20 |
| e | 2.54 BSC | | |
| e1 | 5.08 BSC | | |
| H1 | 6.30 | 6.50 | 6.70 |
| L | 12.78 | 13.08 | 13.38 |
| L1 | - | - | 3.50 |
| L2 | 4.60 REF | | |
| ΦP | 3.55 | 3.60 | 3.65 |
| Q | 2.73 | - | 2.87 |
| $\theta1$ | 1° | 3° | 5° |

Version 1: TO220 -J outline dimension

Ordering Information

| Package Type | Units/ Reel | Reels/ Inner Box | Units/ Inner Box | Inner Box/ Carton Box | Units/ Carton Box |
|--------------|-------------|------------------|------------------|-----------------------|-------------------|
| TO220-J | 50 | 20 | 1000 | 5 | 5000 |

Product Information

| Product | Package | Pb Free | RoHS | Halogen Free |
|-------------|---------|---------|------|--------------|
| OSG50R1K5PF | TO220 | yes | yes | yes |

Legal Disclaimer

The information given in this document shall in no event be regarded as a guarantee of conditions or characteristics. With respect to any examples or hints given herein, any typical values stated herein and/or any information regarding the application of the device, Oriental Semiconductor hereby disclaims any and all warranties and liabilities of any kind, including without limitation, warranties of non-infringement of intellectual property rights of any third party.

For further information on technology, delivery terms and conditions and prices, please contact the Oriental Semiconductor sales representatives (www.orientalsemi.com).

© Oriental Semiconductor Co.,Ltd. All Rights Reserved 